

# EASY PICKET & EASY SHUTTER

A STYLISH AND DURABLE ALUMINIUM FENCING SYSTEM



# EASY PICKET

## PRODUCT FEATURES

The Darley Aluminium Easy Picket system is an attractive concealed fixing solution for all your screening and fencing needs. Easy to install, this powder coated aluminium product is designed to last in harsh environments.

A versatile system comprising of a suite of aluminium extrusions and plastics that provide a complete screening solution, which can be used in both commercial and residential applications.

## CONCEALED FIXING

Easy Picket is a concealed fixing system, designed to hide unsightly screws and rivets. This unique concealed system is both easy-to-install and doesn't require any welding, giving your fencing & gate products a modern attractive look.

## KEY BENEFITS

- Picket fence option - also with concealed fixing
- Optional assembly methods for pickets
- Range of metal corner stakes available
- Low maintenance
- Easy to fabricate and install
- Range of fence and gate configurations
- Resistant to warping, cracking and splintering
- Lasts longer than timber products
- Universal caps available
- Dedicated End Caps
- Wide range of colours\* available
- Available in blade widths of 38mm, 65mm, 75mm and 100mm.

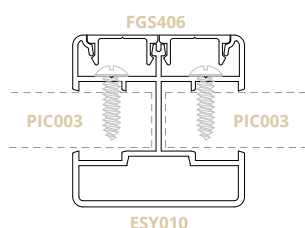

TOP VIEW

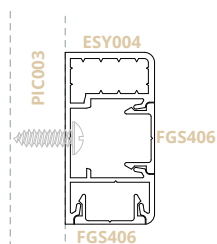

SIDE VIEW

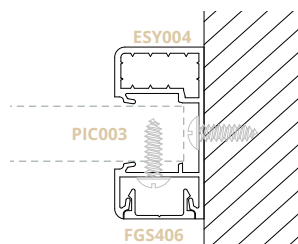

TOP VIEW

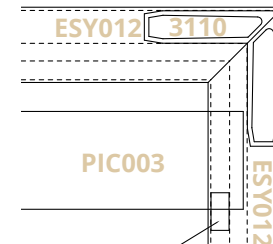

FRONT VIEW

Designed to last in harsh environments.

# EASY PICKET

## EASY-TO-INSTALL

Unlike other systems, Darley's Easy Picket system is easy to fabricate and install with sections that can be assembled and screwed together on site or in the factory. It can easily accommodate different blade widths and can provide adjustable slat spacings when required.

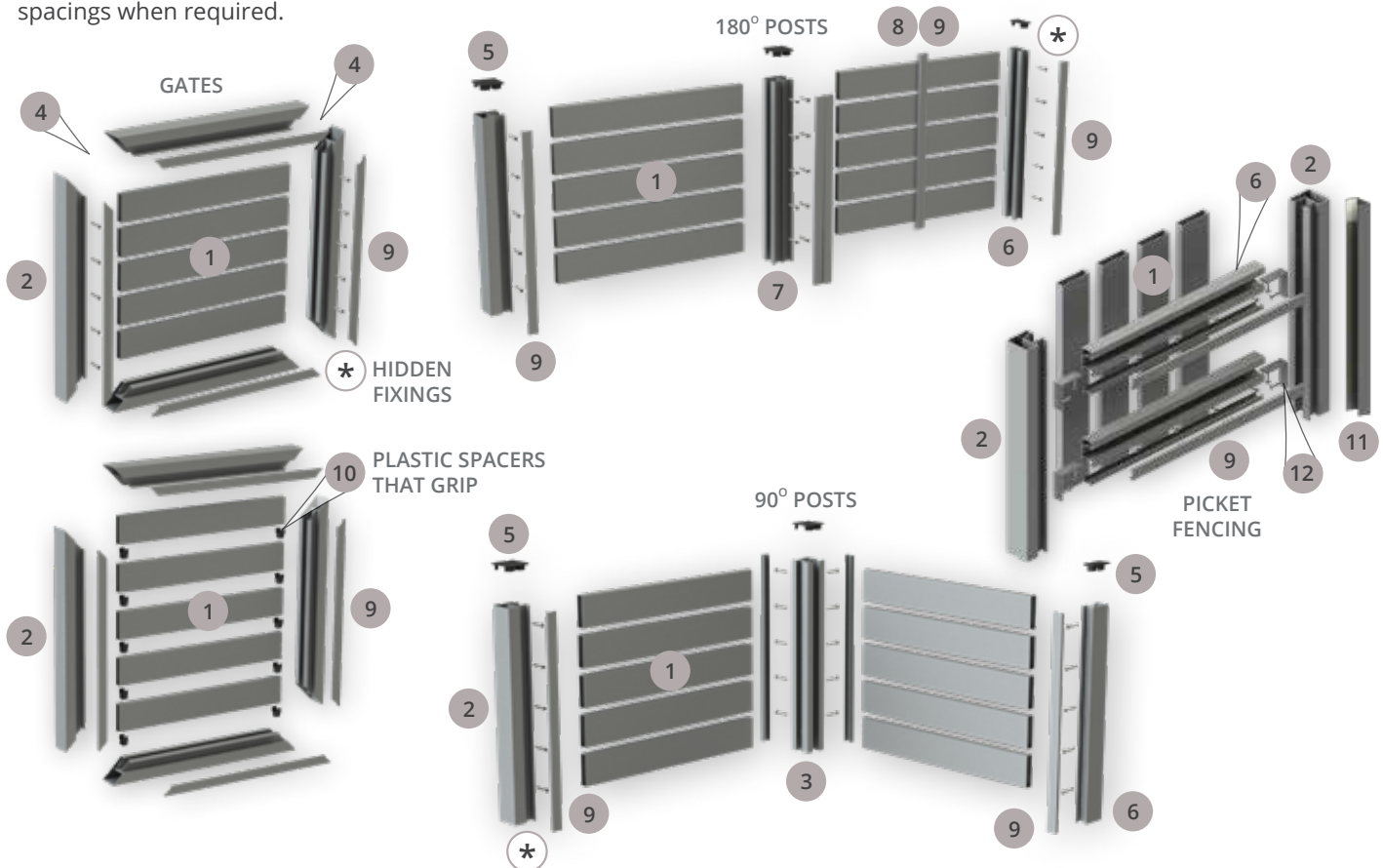

## PICKET SECTIONS

CODE	DESCRIPTION
1	PIC001/PIC002/PIC003/ PIC012/PIC013 or PIC014 Pickets x 16 mm
2	ESY012 Picket post single & gate
3	ESY011 Picket post 90 degree
4	3110 Corner stakes
5	3113 Square top cap
6	ESY004 Jamb / Horizontal receiver
7	ESY010 Picket post 180 degree
8	ESY005 Brace cover
9	FGS406 Pocket filler & Brace
10	3114 Gripping spacer
11	CS100 or TJ325 Post receiver
12	1860 Horizontal brace bracket
*	- Fixings as required

## HARDWARE

### 4 HINGE OPTIONS AVAILABLE

3231	Neutral tension gate hinge, 2 leg (28kg*)
3232	Fixed tension gate hinge, 1 leg (28kg*)
3233	Adjusted tension hinge, 2 leg (70kg*)
3234	Adjusted tension hinge, no leg (70kg*)

^ Alternative hinges available on request for a range of applications.

3241	Trilatch 25cm short gate latch
3244	Trilatch 127cm long gate latch
3242	Viper gravity latch - single sided
3243	Viper gravity latch - double sided
3251	Gate handle

^ Latches and handles available to suit a range of applications.

3211	50x50 Metal top cap (black)
3217	Windsor spear cap - for PIC014 (mill)
3213	90x90 square top cap (black)
3212	Metal base bracket - pair (black)

FABRICATION CUTTING SHEET AVAILABLE ONLINE OR THROUGH YOUR SALES REPRESENTATIVE.



# EASY SHUTTER

## PRODUCT FEATURES

The Darley Aluminium Easy Shutter system is an attractive concealed fixing solution for all your louvre shutter needs. Easy to install, this powder coated aluminium product is designed to last in harsh environments.

A versatile system comprising of a suite of aluminium extrusions and plastics that provide a complete shutter solution, which can be used in both commercial and residential applications.

## CONCEALED FIXING

Easy Shutter is a concealed fixing system, designed to hide unsightly screws and rivets. This unique concealed system is not only easy-to-install, it also doesn't require any welding and gives your shutter products a modern attractive look.

## KEY BENEFITS

- Shutter options with concealed fixing
- Three different styles
- Available in fixed, hinged, sliding, multifolding
- Self-stacking louvre clips
- Low maintenance
- Easy to fabricate and install
- Can be installed in factory or on site
- Resistant to warping, cracking and splintering
- Black or white clips available
- Universal caps available
- Dedicated End Caps
- Wide range of colours\* available



## APPLICATIONS

- Plantation shutters
- Servery windows
- Fencing & gates
- Sunscreens
- Privacy screening
- Area dividers
- Equipment enclosures

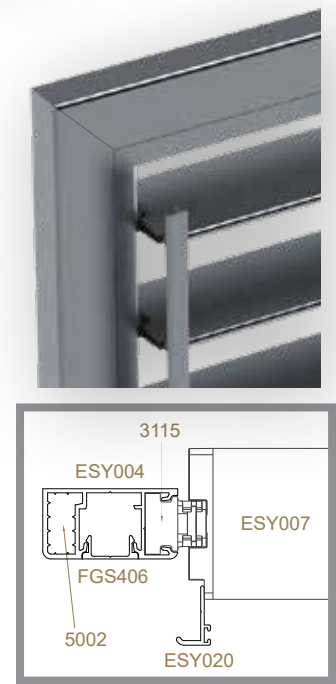
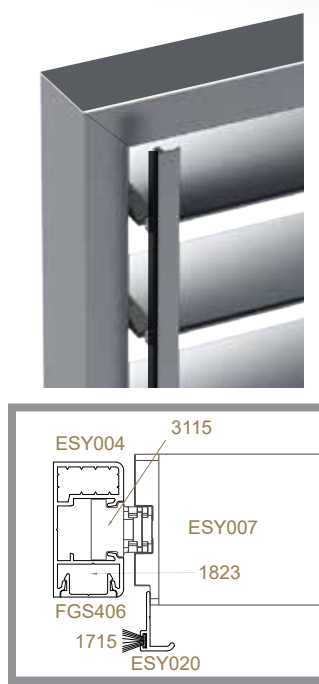

Designed to last in harsh environments.

# EASY SHUTTER



ORLEANES

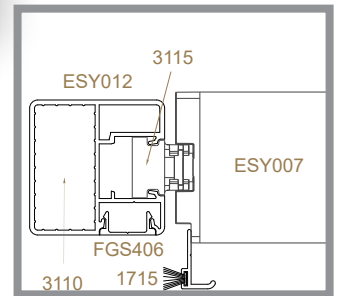

Cross Section



LORRAINE

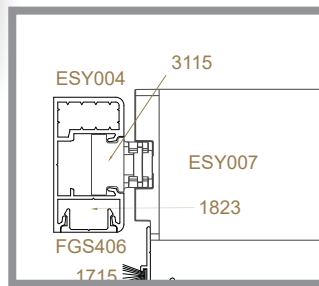

Cross Section



SARTHE

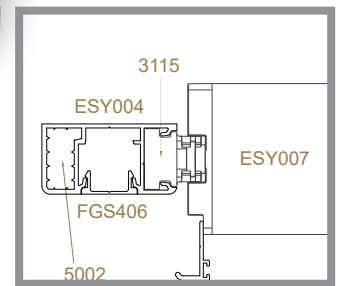

Cross Section

## SHUTTER SECTIONS

CODE	DESCRIPTION
1 ESY020	Shutter Control Bar
2 ESY007	70mm Elliptical Blade
3 ESY004	Lorraine & Sarthe Frame
4 ESY012	Orleanses Frame
5 1715	Control Bar Weatherstrip

## HARDWARE

CODE	DESCRIPTION
6 3115	Shutter Insert Set
7 3110	Orleanses Corner Stake
8 1823	Lorraine Corner Stake
9 5002	Sarthe Corner Stake
*	7 8 or 9, see configs

FABRICATION CUTTING SHEET AVAILABLE ONLINE OR THROUGH YOUR SALES REPRESENTATIVE.

# EASY PICKET & EASY SHUTTER PROFILES

## PICKET PROFILES

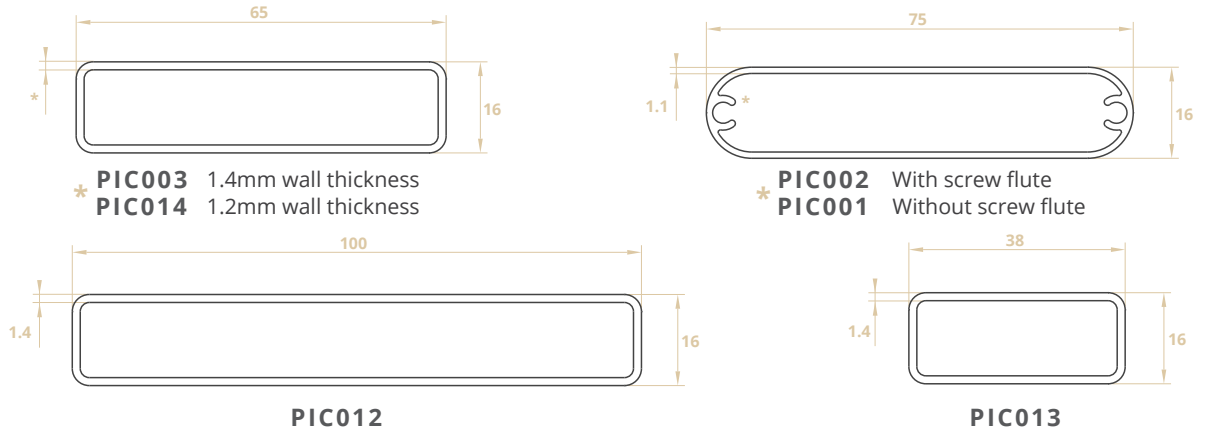

## MULTI-FUNCTIONAL PROFILES

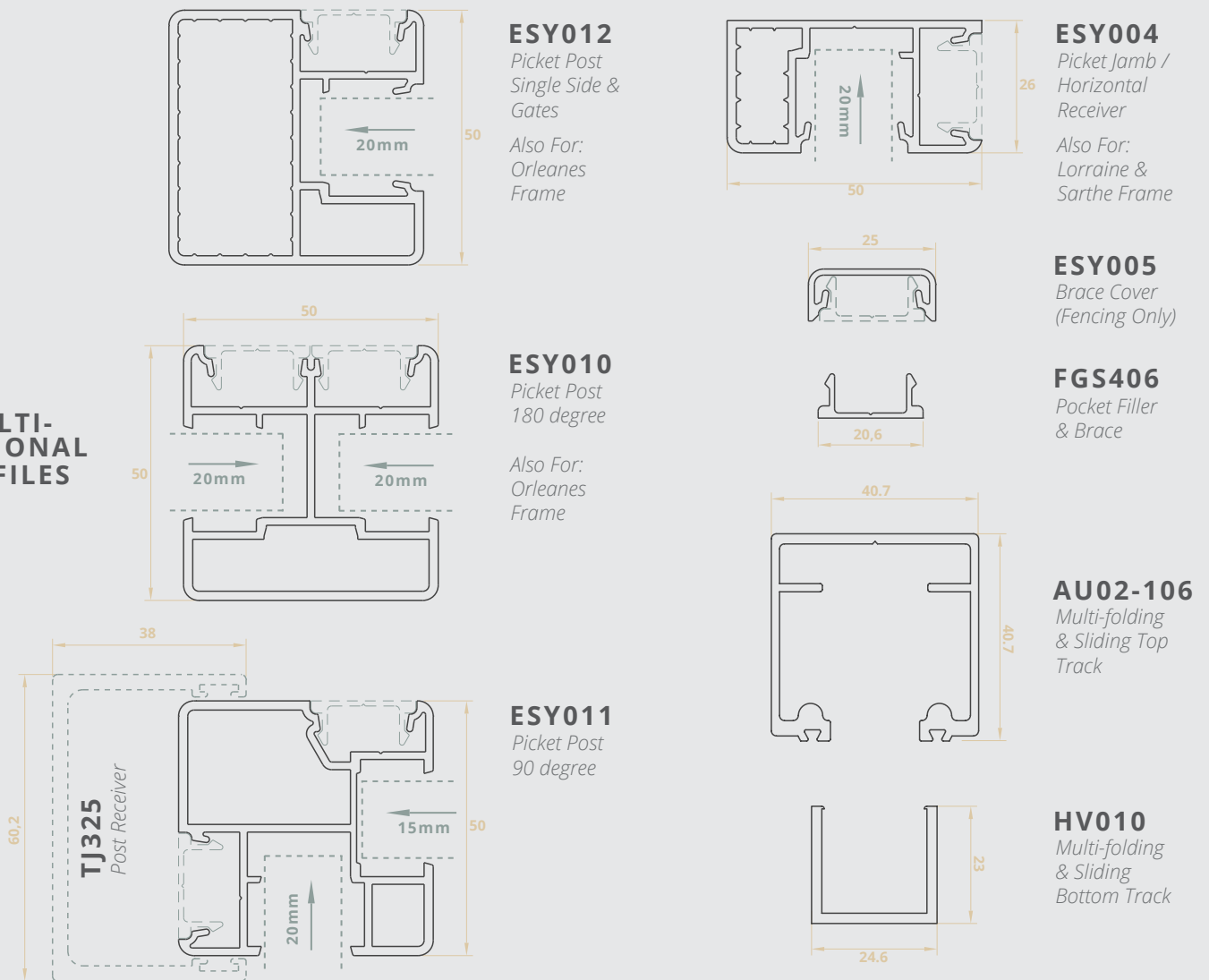

## SHUTTER PROFILES

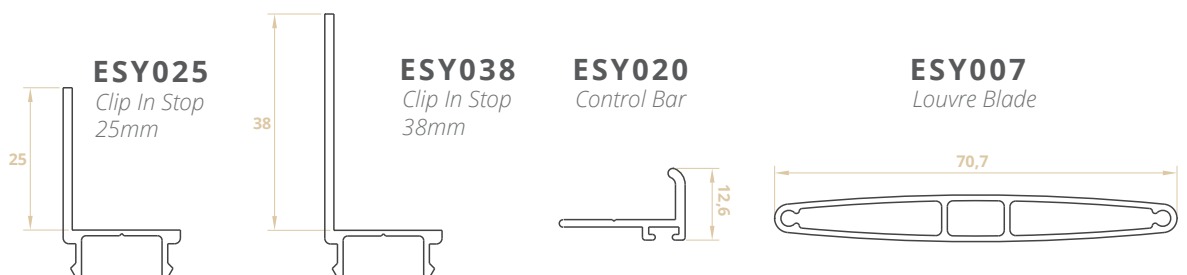

Designed to last in harsh environments.

\*Flyscreening available

# EASY PICKET & EASY SHUTTER HARDWARE

## EASY PICKET GRIPPING SPACER

- Dual purpose spacer grips pickets during install
- 12mm spacer (24mm when stacked)
- Black/white finish that hides inside the post



## SHUTTER INSERT (10 PAIRS)

SUITS ESY012,  
ESY004 & ESY010\*  
(BLACK/WHITE)



## WINDSOR SPEAR CAP

SUITS PIC012 ONLY

(MILL FINISH)



## END CAP PICKET

SUITS PIC003 & PIC012

(BLACK)



## HORIZONTAL BRACE BRACKET

SUITS PICKET FENCE



## 50 x 50 TOP CAP WITH BREAK-OFF

For use with ESY004 half post break in two.  
(BLACK)



## 90 x 90 POST TOP CAP

SUITS SQF9090T20

(BLACK)

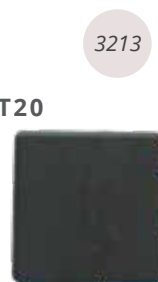

## 50 x 50 POST METAL TOP CAP

(BLACK)

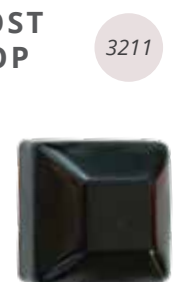

## 50 x 50 POST METAL BASE BRACKET (1 PAIR)

(BLACK)



## 50 X 50 POST BASE COVER

(BLACK)



## POST BASE SUITS ESY012

Coming Soon

## CORNER STAKE SUITS ESY012

FOR GATES AND SHUTTERS



## CORNER STAKE SUITS ESY004 FOR LORRAINE



## CORNER STAKE SUITS ESY004 FOR SARTHE



# ADDITIONAL HARDWARE

## HINGES & LATCHES

Safetech is a global leader in the manufacture of door lock hardware, manufacturing some of the safest leading-edge hardware products. Made using the finest materials including fibre re-inforced quality polymers, aluminium and stainless steel, SafeTech hinges and latches have a lifetime warranty\* and are regularly tested by NATA accredited laboratories.



### NEUTRAL TENSION GATE HINGE 2 LEGS

Holding Weight: 28kg

3231



### FIXED TENSION GATE HINGE 1 LEG

Holding Weight: 28kg

Closing Weight: 15kg

3232



### ADJUSTABLE TENSION GATE HINGE 2 LEGS

Holding Weight: 70kg

Closing Weight: 45kg

3233



### ADJUSTABLE TENSION GATE HINGE NO LEGS

Holding Weight: 70kg

Closing Weight: 45kg

3234



### TRILATCH 25CM SHORT GATE LATCH

Adjustment: Horizontal & Vertical

3241



### TRILATCH 127MM LONG GATE LATCH

Adjustment: Horizontal & Vertical

3244



### GRAVITY SINGLE LATCH

Adjustment: Horizontal & Vertical

3242



### VIPER GRAVITY DOUBLE LATCH

Adjustment: Horizontal & Vertical

3243



### GATE HANDLE

Easy to install  
Elegant design

3251

ALL GATE HARDWARE AVAILABLE IN BLACK ONLY  
\*For lifetime warranty terms and conditions on Safetech hardware, please contact your local branch.

## MULTI-FOLD & SLIDING HARDWARE

3309 HINGE

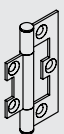

15401 FLUSH PULL

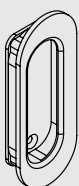

3304 MULTIFOLD BARREL BOLT



3314 MULTIFOLD BOLT 140MM

3314 MULTIFOLD BOLT 450MM



3308 PIVOT

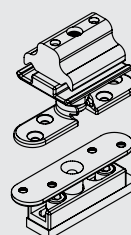

3307 TOP HANGER

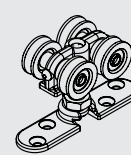

3310 BOTTOM GUIDE

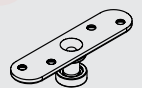

1680-H BOTTOM GUIDE INSERT

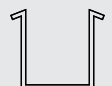

Designed to last in harsh environments.



# COLOUR OPTIONS

## WIDE RANGE OF COLOUR AND FINISH OPTIONS

Darley's Easy Picket system can be powdercoated using a large range of Dulux & Interpon colours. The colours listed below are some of the colours available, speak to your Darley Sales Representative about colour availability and powdercoat lead times.\*



*Darley Aluminium in WA stock Easy Picket and Easy Shutter sections in these colours\* & Mill Finish.*



## 10 YEAR WARRANTY

A 10 year warranty applies, from the date of installation.



---

#### **SYDNEY HEAD OFFICE**

8 Tyrone Place  
Erskine Park NSW 2759  
T: (02) 8887 2888  
F: (02) 9834 3244

E: [sales@darleyaluminium.com.au](mailto:sales@darleyaluminium.com.au)

#### **MELBOURNE**

10 Bridge Road  
Keysborough VIC 3173  
T: (03) 9238 3888  
F: (03) 9768 7288

E: [salesvic@darleyaluminium.com.au](mailto:salesvic@darleyaluminium.com.au)

#### **BRISBANE**

29 Access Avenue  
Yatala QLD 4207  
T: (07) 3287 1888  
F: (07) 3287 2088

E: [salesqld@darleyaluminium.com.au](mailto:salesqld@darleyaluminium.com.au)

#### **PERTH**

36 Armstrong Road  
Hope Valley WA 6165  
T: (08) 9437 2999  
F: (08) 9437 1024

E: [saleswa@darleyaluminium.com.au](mailto:saleswa@darleyaluminium.com.au)

